

## **PLEASE READ**

This manual is provided as a free service by Projector.com.

We are in no way responsible for the contents of the manual. We do not guarantee its accuracy and we do not make any claim of copyright. The copyright remains the property of their respective owners.

## **ABOUT PROJECTOR.COM**

Projector.com (<http://www.projector.com>) is your review and buying guide resource for DLP and LCD video projectors.

Visit the site to read the latest projector news and reviews, read and comment on projector specifications, download user manuals and much more.

# **DUKANE**

## **Liquid Crystal Projector Model 8053**

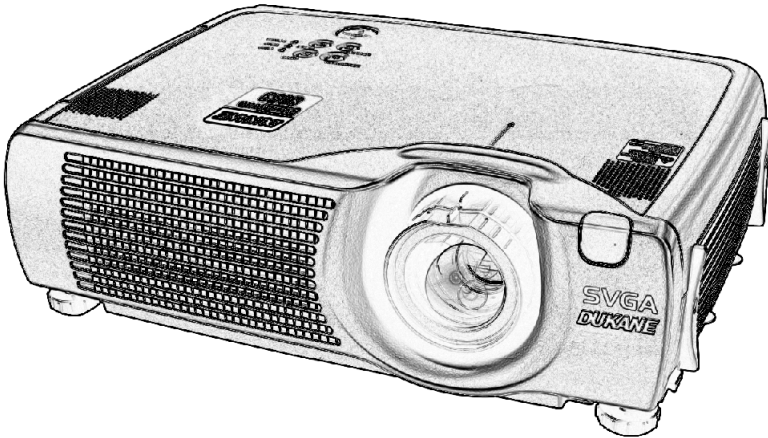

### **USER'S MANUAL**



# USER'S MANUAL

Thank you for purchasing this liquid crystal projector.

**WARNING** • Please read the accompanying manual “SAFETY INSTRUCTIONS” and this “USER'S MANUAL” thoroughly to ensure correct usage through understanding. After reading, store this instruction manual in a safe place for future reference.

**NOTE** • The information in this manual is subject to change without notice.

- The manufacturer assumes no responsibility for any errors that may appear in this manual
- The reproduction, transmission or use of this document or contents is not permitted without express written authority.

**TRADEMARK ACKNOWLEDGMENT** : PS/2, VGA and XGA are registered trademarks of International Business Machines Corporation. Apple, Mac and ADB are registered trademarks of Apple Computer, Inc. VESA and SVGA are trademarks of the Video Electronics Standard Association. Windows is a registered trademark of Microsoft Corporation. Carefully observe the trademarks and registered trademarks of all companies, even when not mentioned.

## CONTENTS

	Page		Page
<b>FEATURES</b> .....	<b>2</b>	<b>TROUBLESHOOTING</b> .....	<b>20</b>
<b>BEFORE USE</b> .....	<b>2</b>	OSD Message .....	20
Contents of Package .....	2	Indicators Message .....	21
Part Names.....	3	Symptom .....	22
Loading the Batteries.....	5	<b>SPECIFICATIONS</b> .....	<b>23</b>
<b>INSTALLATION</b> .....	<b>6</b>	<b>WARRANTY AND AFTER-SERVICE</b> .....	<b>24</b>
Installation of the Projector and Screen.....	6	<b>TECHNICAL SECTION</b> .....	<b>I-VI</b>
Angle Adjustment .....	6	<b>TABLES</b>	
Cabling .....	7	Table 1. Installation Reference.....	6
Power Connection .....	8	Table 2. Cabling .....	7
Example of System Setup .....	8	Table 3. Basic Operation .....	10
Plug & Play .....	8	Table 4. Setup Menu .....	12
<b>OPERATIONS</b> .....	<b>9</b>	Table 5. Input Menu.....	13
Power ON .....	9	Table 6. Image Menu.....	14
Power OFF .....	9	Table 7. Options Menu .....	15
Basic Operation .....	10	Table 8. No Signal Menu .....	16
Setup Menu .....	12	Table 9. OSD Message .....	20
Input Menu.....	13	Table 10. Indicators Message .....	21
Image Menu.....	14	Table 11. Symptom .....	22
Options Menu .....	15	Table 12. Specifications .....	23
No Signal Menu .....	16	.....	
<b>MAINTENANCE</b> .....	<b>17</b>	For "TECHNICAL" and "REGULATORY	
Lamp.....	17	NOTICE", see the end of this manual.	
Air Filter .....	19		
Other Maintenance .....	19		

# FEATURES

This liquid crystal projector is used to project various computer signals as well as NTSC / PAL / SECAM video signals onto a screen. Little space is required for installation and large images can easily be realized.

## Outstanding Brightness

The UHB lamp and high-efficiency optical system assure a high level of brightness.

## Partial Magnification Function

Interesting parts of images can be magnified for closer viewing.

## Distortion Correction Function

Distortion-free images are quickly available.

## Extra-low Noise Function

Acoustic noise level from the unit can be reduced.

# BEFORE USE

## Contents of Package

Make sure all of the following items are included in the package. If anything is missing, please contact your dealer.

**WARNING** • Keep the original packing material for future reshipment. To avoid penetration of foreign objects, do not put the projector into a case or bag together with anything except the accessories of the projector, signal cables and connectors.

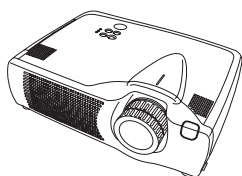

**Projector**  
(with Lens Cap)



**User's Manual**  
(this manual)

**Safety Instructions**



**Soft case**

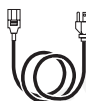

**Power Cord**  
(US Type)



**Power Cord**  
(UK Type)



**Power Cord**  
(Europe Type)



**RGB Cable**

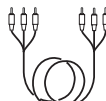

**Component**  
**Video Cable**

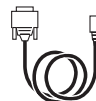

**Mouse cable**  
(PS/2)



**Batteries**  
for Remote Control  
Transmitter



**Remote Control**  
**Transmitter**

# BEFORE USE (continued)

## Part Names

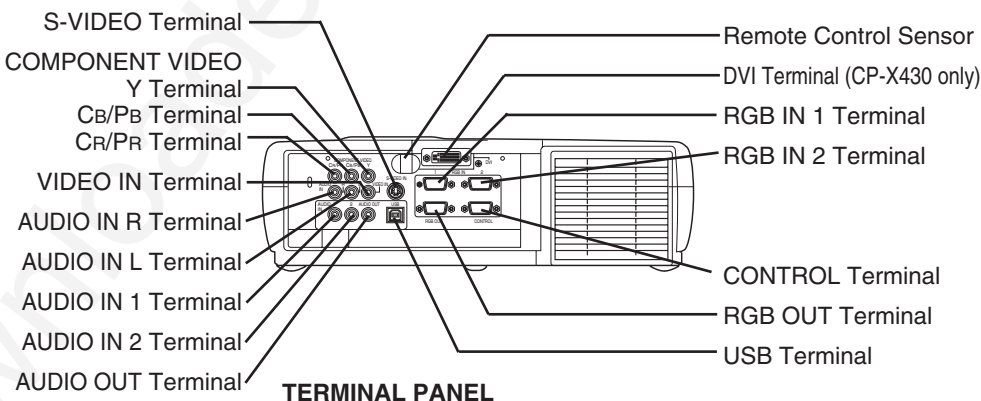
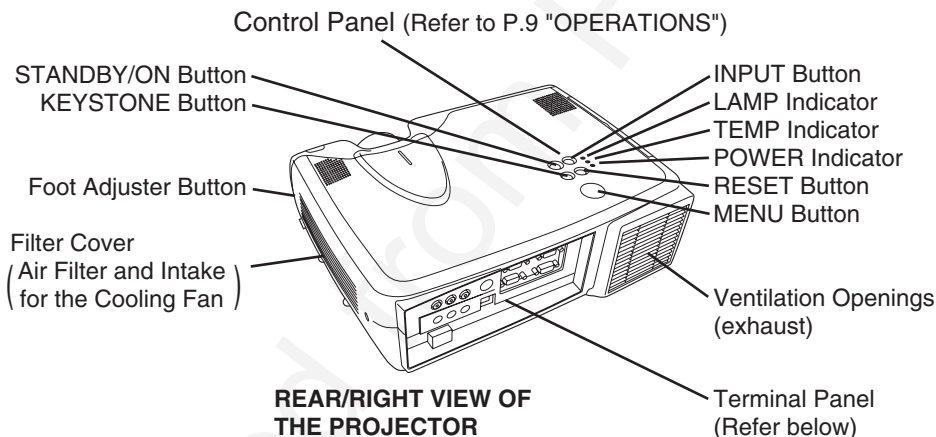
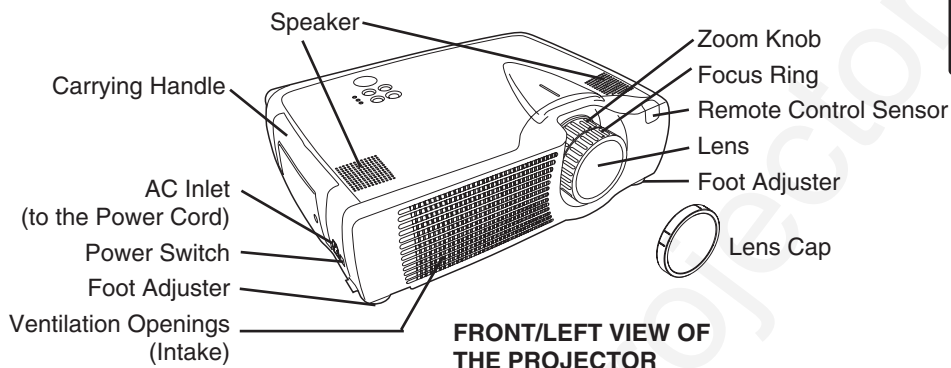

# BEFORE USE (continued)

## Part Names (continued)

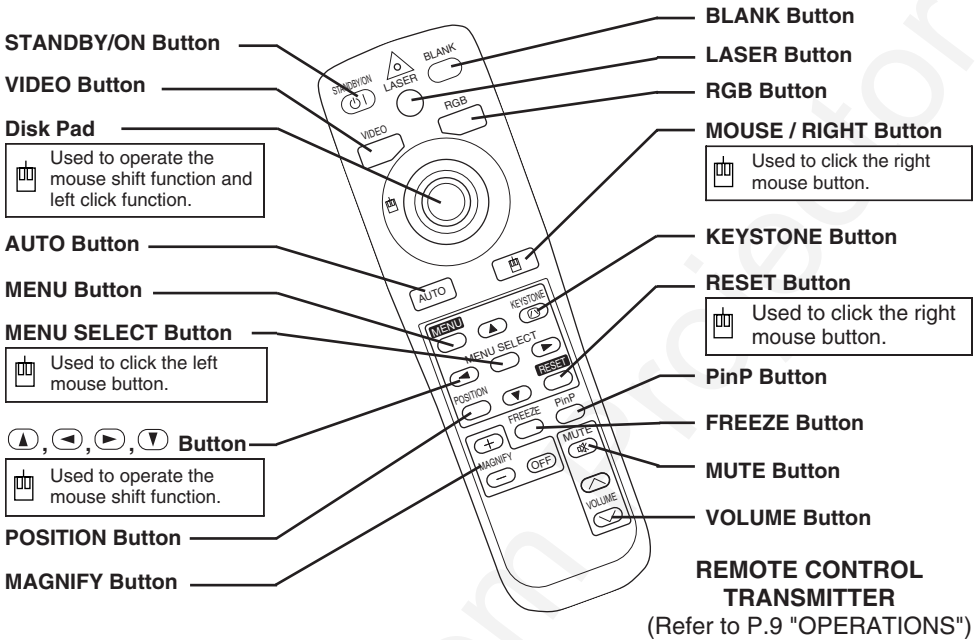

These functions work when the mouse control function is activated. Remember, the POSITION, BLANK ON and MENU ON functions disable the mouse control function.

- WARNING** • The laser pointer of the remote control transmitter is used in place of a finger or rod. Never look directly into the laser beam outlet or point the laser beam at other people. The laser beam can cause vision problems.
- CAUTION** • Use of controls or adjustments or performance of procedures other than those specified herein may result in hazardous radiation exposure.

AVOID EXPOSURE-  
LASER RADIATIONS IS  
EMITTED FROM THIS  
APERTURE

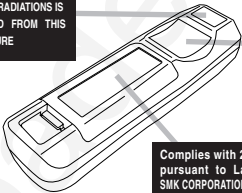

**CAUTION**  
LASER RADIATION-  
DO NOT STARE INTO BEAM  
★  
MAX. OUTPUT: 1mW  
WAVE LENGTH: 650nm  
CLASS II LASER PRODUCT

LASER RADIATION-  
DO NOT STARE INTO BEAM  
CLASS II LASER PRODUCT  
MAX. OUTPUT: 1mW  
WAVE LENGTH: 650nm  
©2005-11-1993-A1-1997



Complies with 21 CFR 1040.10 and 1040.11 except for deviations pursuant to Laser Notice No.50, dated 2001.7.26  
SMK CORPORATION  
6-5-5, Togoshi Shinagawa-ku, Tokyo, JAPAN 142-8511  
MANUFACTURED November 2001  
PLACE OF MANUFACTURER: A

- NOTE** • Keep the remote control transmitter away from children and pets.
- Do not give the remote control transmitter any physical impact. Take care not to drop.
  - Do not place the heavy objects on the remote control transmitter.
  - Do not wet the remote control transmitter or place it on any wet object.
  - Do not place the remote control transmitter close to the cooling fan of the projector.
  - Do not disassemble the remote control transmitter.

# BEFORE USE (continued)

## Loading the Batteries

Install the AA batteries into the remote control transmitter.

1. Remove the battery cover.  
Push the knob while lifting up the battery cover.
2. Load the batteries.  
Make sure the plus and minus poles are correctly oriented.
3. Close the battery cover.

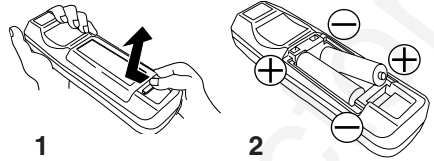

**CAUTION** • Use only the specified batteries with this remote control transmitter. Also, do not mix new and old batteries. This could cause battery cracking or leakage, which could result in fire or personal injury.

- When loading the batteries, make sure the plus and minus terminals are correctly oriented as indicated in the remote control transmitter. Incorrect orientation could cause battery cracking or leakage, which could result in personal injury or pollution of the surrounding environment.
- When you dispose the battery, you should obey the law in the relative area or country.
- Keep the battery away from children and pets.
- When not to be used for an extended period, remove the batteries from the remote control transmitter.

**NOTE** Replace the batteries when remote control transmitter operation becomes difficult.



# INSTALLATION

## Installation of the Projector and Screen

Refer to the drawing and table below for determining the screen size and projection distance.

The projection distances shown in the table below are for full size (CP-S420:800 x 600 pixels , CP-X430:1024 x 768 pixels).

a: Distance from the projector to the screen. ( $\pm 10\%$ )

**Table 1. Installation Reference**

Screen size [inches (m)]	a [inches (m)]	
	Min.	Max.
40 (1.0)	62 (1.6)	82 (2.1)
60 (1.5)	94 (2.4)	123 (3.1)
80 (2.0)	127 (3.2)	164 (4.2)
100 (2.5)	160 (4.1)	205 (5.2)
120 (3.0)	192 (4.9)	246 (6.3)
150 (3.8)	241 (6.1)	308 (7.8)
200 (5.0)	323 (8.2)	411 (10.4)

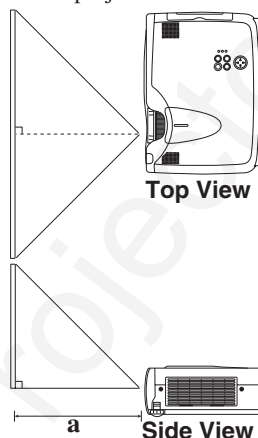

**CAUTION** • Install the projector in a suitable environment according to instructions of the accompanying manual “SAFETY INSTRUCTIONS” and this manual.

• When you fix this unit with a metal tool and the like, you must connect it with ground wire; otherwise, fire or electric shock can result.

Connect the ground terminal of AC inlet of this unit with the ground terminal provided at the building using an optional three-core power-supply cord.

• Please basically use liquid crystal projector at the horizontal position. If you use liquid crystal projector by the lens up position, the lens down position and the side up position, this may cause the heat inside to build up and cause damage. Be especially careful not to install it with ventilation holes blocked.

• Do not install LCD projector in smoke effected environment. Smoke residue may buildup on critical parts (i.e.LCD panel, Lens Assy etc.).

## Angle Adjustment

Use the foot adjusters on the bottom of the projector to adjust the projection angle. It is variable within  $0^\circ$  to  $9^\circ$  approximately.

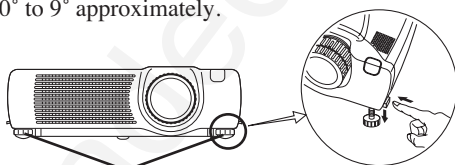

Foot Adjusters

Press the foot adjuster button

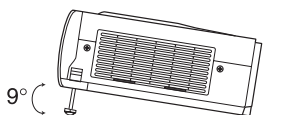

1. Lift up the front side of the projector, and pressing the foot adjuster button, adjust the projection angle.
2. Release the button to lock at the desired angle.
3. Use the foot adjusters for fine adjustment. Do not force the adjuster screws. This could damage the adjusters or cause the lock to fail.



**CAUTION** • Do not release the foot adjuster button unless the projector is being held; otherwise, the projector could overturn or fingers could get caught and cause personal injury.

# INSTALLATION (continued)

## Cabling

Refer to the table below for connecting each terminal of the projector to a device.

**Table 2. Cabling**

Function	Terminal	Cable
RGB input	RGB IN 1	RGB cable with D-sub 15-pin shrink jack and inch thread screws
	RGB IN 2	
RGB output	RGB OUT	
DVI input (CP-X430 only)	DVI	DVI cable with inch thread screws
Audio input (from the computer)	AUDIO IN 1 (interlocked with RGB IN 1 or DVI)	Audio cable with stereo mini jack
	AUDIO IN 2 (interlocked with RGB IN 2)	
PS/2 mouse control	CONTROL	PS/2 mouse cable
ADB mouse control		ADB mouse cable
Serial mouse control		Serial mouse cable
RS-232C communication		RS-232C cable
USB mouse control	USB	USB cable
S-video input	S-VIDEO IN	S-video cable with mini DIN 4-pin jack
Video input	VIDEO IN	Video/Audio cable
Component video input	COMPONENT VIDEO Y	Component Video cable
	COMPONENT VIDEO Cb/Pb	
	COMPONENT VIDEO Cr/Pr	
Audio input (from video equipment)	AUDIO IN L	Video/Audio cable or Audio cable with RCA jack
	AUDIO IN R	
Audio output	AUDIO OUT	Audio cable with stereo mini jack



**CAUTION** • Incorrect connecting could result in fire or electrical shock. Please read this manual and the separate “SAFETY INSTRUCTIONS”.

- Before connecting, turn off to all devices to be connected, except for the USB cable.
- The cables may have to be used with the core set to the projector side. Use the cables which are included with the projector or specified.

**NOTE** • Before connecting, read instruction manuals of the devices to be connected, and make sure that the projector is compatible with the device.

- Secure the screws on the connectors and tighten.
- For some RGB input modes, the optional Mac adapter is necessary.
- To select the DVI input, the computer may need some settings. See the manuals of the computer for details.
- Some computers may have multiple display screen modes. Use of some of these modes will not be possible with this projector.
- Refer to the “TECHNICAL” section for the pin assignment of connectors and RS-232C communication data.
- When the DVI terminal is used, the RGB OUT terminal may not function.

# INSTALLATION (continued)

## Power Connection

Use the correct power cord depending on the power outlet to be used.

Connect the AC inlet of the projector to the power outlet firmly by the power cord.



**CAUTION** • Be careful in handling the power cord according to instructions of the accompanying manual "SAFETY INSTRUCTIONS" and this manual.

- Connect the power cord firmly. Avoid using a loose, unsound outlet or failed contact.

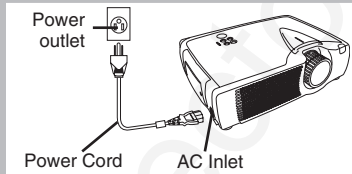

## Example of System Setup

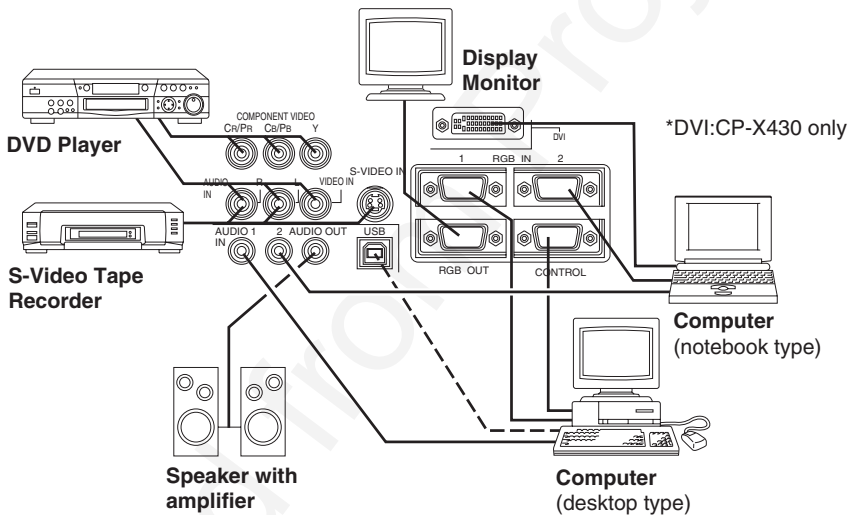

**NOTE** • When connecting with a notebook computer, set the proper RGB external image output (setting CRT display or simultaneous display of LCD and CRT). Please read instruction manual of the notebook for more information.

## Plug & Play

This projector is VESA DDC 1/2B compatible. Plug & play is possible by connecting to a computer that is VESA DDC (Display Data Channel) compatible.

Please use this function by connecting the RGB cable with RGB IN 1 terminal (DDC 1/2B compatible), or by connecting a DVI cable with DVI terminal (CP-X430 only/DDC 2B compatible). Plug & play may not operate by other connections.

**NOTE** • Plug & play is a system configured with peripheral equipment including a computer, display and an operating system.

- This projector is recognized as a plug & play monitor. Use the standard display drivers.
- Plug & play may not operate by the computer to connect. Use the RGB IN 2 terminal if plug & play does not operate correctly.

# OPERATIONS

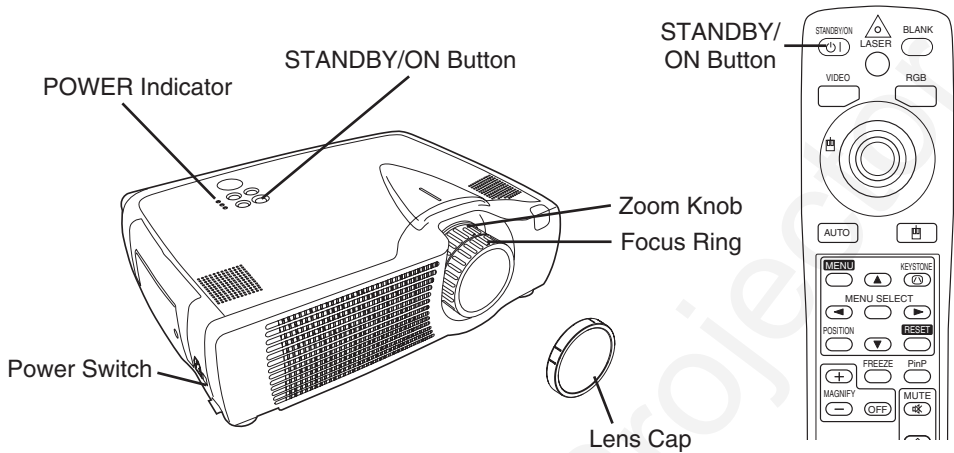

## Power ON

1. Check that the power cord is connected correctly.
2. Set the power switch to [I]. The standby mode is selected, and the POWER indicator is turned to orange.
3. Press the STANDBY/ON button (⏻) on the control panel or the remote control transmitter. Warm-up begins and the POWER indicator blinks in green.
4. The POWER indicator ceases blinking and turns to green when power is on. Remove the lens cap.
5. Adjust picture size using the zoom knob.
6. Adjust focus using the focus ring .

## Power OFF

1. Press the STANDBY/ON button (⏻) on the control panel or the remote controller. Then, the message "Power off?" will appear on the screen, and the message will disappear by any operation or no operation for 5 seconds. During this message indication, press the STANDBY/ON (⏻) button again. The projector lamp is extinguished and lamp cooling begins. The POWER indicator blinks orange during lamp cooling. Pressing the STANDBY/ON button (⏻) has no effect while the POWER indicator is blinking.
2. The system assumes the Standby mode when cooling is complete, and the POWER indicator ceases blinking and changes to orange. Check that the indicator is orange and set the power switch to [O].
3. The POWER indicator is extinguished when power is off. Do not forget to attach the lens cap.



**WARNING** • Please read this manual, and the separate "SAFETY INSTRUCTIONS" thoroughly before using the equipment. Always ensure that the equipment is used safely.

- NOTE** • Except in emergencies, follow the above-mentioned procedure for turning power off. If the projector is used improperly, it may very difficult to turn off the projector caused by heating inside the unit. And the reduction of life time of lamp and LCD panels will be caused by incorrect procedure.
- To prevent any trouble, turn on/off the projector when the computer or video tape recorder is OFF. Providing a RS-232C cable is connected, turn on the computer before the projector.
  - When a projector continues projecting the same image, the image may remain as an afterimage. Please do not project the image same for a long time.

# OPERATIONS (continued)

## Basic Operation

The basic operations shown in Table 3 is performed from the supplied remote control transmitter or the projector control panel. Items indicated by (\*) may be used from the control panel.

**Table 3 . Basic Operation**













Item	Description
INPUT SELECT	<p><b>Select Input Signal (*)</b> : Press the INPUT button.            RGB IN 1→RGB IN 2→DVI→ VIDEO IN → S-VIDEO IN → COMPONENT VIDEO (→ RGB IN 1)</p> <p><b>Select RGB Input</b> : Press the RGB button.            VIDEO IN / S-VIDEO IN / COMPONENT VIDEO → RGB IN 1 / RGB IN 2 / DVI            RGB IN 1 → RGB IN 2 → DVI (→ RGB IN 1)</p> <p><b>Select Video Input</b> : Press the VIDEO button.            RGB IN 1 / RGB IN 2 / DVI → VIDEO IN / S-VIDEO IN / COMPONENT VIDEO            VIDEO IN → S-VIDEO IN → COMPONENT VIDEO (→ VIDEO IN)</p> <ul style="list-style-type: none"> <li>• The selected signal name is displayed for approximately 3 seconds when the input signal is changed.</li> <li>• Only for CP-X430, DVI exists.</li> </ul>
POSITION	<p><b>Set/Clear Position Adjustment Mode</b> : Press the POSITION button.            The [ ] icon is displayed in the POSITION mode.</p> <p><b>Image Position Adjustment</b>: Press the ←, →, ▲ and ▼ buttons in the POSITION mode.</p> <ul style="list-style-type: none"> <li>• Valid only in the MAGNIFY mode with a video signal is input.</li> <li>• After approximately 10 seconds of inactivity the [ ] icon is extinguished and the POSITION mode is cleared automatically.</li> <li>• ←, →, ▲ and ▼ buttons may operate as the mouse control button. Refer to page 4.</li> </ul>
RESET (*)	<p><b>Initialize Each Item</b> : Select an item and press the RESET button.</p> <p><b>Initialize Position Adjustment</b> : Press the RESET button and the POSITION mode. This function is valid only when RGB signal is input.</p> <ul style="list-style-type: none"> <li>• Valid except for the VOLUME, LANGUAGE and H PHASE.</li> <li>• The RESET button may operate as the mouse control button. Refer to page 4.</li> </ul>
MAGNIFY	<p><b>Set MAGNIFY Mode</b> : Press the MAGNIFY ⊕ button.</p> <p><b>Move Magnified Area</b> : Run the POSITION in the MAGNIFY mode.</p> <p><b>Adjust Magnification</b> : Press the MAGNIFY ⊕ / ⊖ button in MAGNIFY mode.</p> <p><b>Clear MAGNIFY Mode</b> : Press the MAGNIFY ⊖ button.</p> <ul style="list-style-type: none"> <li>• The MAGNIFY mode is cleared by running or setting the AUTO, ASPECT, INPUT SELECT or VIDEO, or by changing the input signal.</li> </ul>
FREEZE	<p><b>Set/Clear FREEZE Mode</b> : Press the FREEZE button. The [ ] icon is displayed, and the image is frozen, in the FREEZE mode.</p> <ul style="list-style-type: none"> <li>• The FREEZE mode is cleared by running or setting POSITION, VOLUME, MUTE, Automatic Adjustment, BLANK ON/OFF, or MENU ON/OFF, or by changing the input signal.</li> <li>• Do not forget to clear frozen static images.</li> </ul>

**NOTE** • Strong light and obstacles will interfere with operation of the remote control transmitter.

# OPERATIONS (continued)

Items indicated by (\*) may be used from the control panel.

**Table 3. Basic Operation (continued)**

Item	Description
VOLUME	<b>Volume Adjustment</b> : Press the VOLUME  /  button.
MUTE	<b>Set/Clear Mute Mode</b> : Press the MUTE button. No sound is heard in the MUTE mode.
AUTO	<p><b>Automatic Adjustment at RGB Input</b> : Press the AUTO button. Horizontal position(H.POSIT), vertical position (V.POSIT),clock phase (H.PHASE), and horizontal size(H.SIZE) are automatically adjusted. Use with the window at maximum size in the application display.</p> <p><b>Automatic Adjustment at Video Input</b> : Press the AUTO button. A signal type appropriate for the input signal is selected automatically. Valid only when AUTO is set for VIDEO on the menu.</p> <ul style="list-style-type: none"> <li>• This operation requires approximately 10 seconds. It may not function correctly with some input signals.</li> </ul>
BLANK ON/OFF	<b>Set/Clear Blank Mode:</b> Press the BLANK button. No image is displayed in the Blank mode. The screen color is as set in BLANK on the Image menu.
MENU ON/OFF (*)	<p><b>Menu Display Start/Stop:</b> Press the MENU button.</p> <ul style="list-style-type: none"> <li>• The menu display is terminated automatically after approximately 10 seconds of inactivity.</li> </ul>
MENU SELECT	<p><b>Select Menu Type:</b> Press the MENU SELECT button. Allows the user to select the normal menu or the single menu. Only the selected item is displayed on the single menu, and other items are displayed with the  and  buttons as with the normal menu.</p> <ul style="list-style-type: none"> <li>• Valid only when the Setup menu is used. Push the MENU SELECT button after selecting items such as "BRIGHTNESS".</li> <li>• The MENU SELECT button may operate as the mouse control button. Refer to page 4.</li> </ul> <div style="text-align: center;"> <p><b>Normal menu</b>    <b>Single menu</b></p>  <p style="margin-left: 200px;">(MENU SELECT)</p> </div>
P.IN P. MODE	<p><b>Select Mode of P.IN P. Display</b> : Press the PinP button.</p> <p>Small → Large → P.IN P. off ( → Small)</p> <ul style="list-style-type: none"> <li>• P.IN P. function superimposes a video image over RGB or DVI signals.</li> </ul>
KEYSTONE	<p><b>Set / Clear KEYSTONE Mode (*)</b> : Press the KEYSTONE  button.</p> <p><b>Select KEYSTONE Mode</b> : Press the  /  button in the KEYSTONE mode. Vertical  ↔  Horizontal</p> <p><b>Adjust KEYSTONE</b> : Press the  /  button.</p> <ul style="list-style-type: none"> <li>• The image may not be appeared properly when this function is activated on same input signals.</li> <li>• The adjustable range of distortion correction will be different among input signals.</li> </ul>

# OPERATIONS (continued)

## Setup Menu

The following adjustments and settings are possible when SETUP is selected at the top of the menu. Part of the Setup menu differs between RGB input and video input. Select an item with the  $\blacktriangle$  and  $\blacktriangledown$  buttons, and start operation. Use the Single menu to reduce menu size (see Table 3, MENU SELECT).

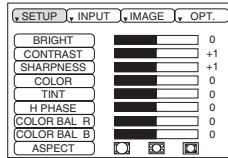
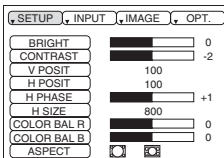

**RGB IN 1  
RGB IN 2  
DVI (CP-X430 only)**

**VIDEO  
S-VIDEO  
COMPONENT VIDEO**

**Table 4. Setup Menu**

Item	Description	RGB IN 1 RGB IN 2	DVI (CP- X430 only)	VIDEO S-VIDEO COMPONENT
BRIGHT	<b>Adjustment:</b> Dark $\blacktriangleleft$ $\leftrightarrow$ Light $\blacktriangleright$	✓	✓	✓
CONTRAST	<b>Adjustment:</b> Weak $\blacktriangleleft$ $\leftrightarrow$ Strong $\blacktriangleright$	✓	✓	✓
V POSIT	<b>Adjustment:</b> Down $\blacktriangleleft$ $\leftrightarrow$ Up $\blacktriangleright$	✓	-	-
H POSIT	<b>Adjustment:</b> Left $\blacktriangleleft$ $\leftrightarrow$ Right $\blacktriangleright$	✓	-	-
H PHASE	<b>Adjustment:</b> Left $\blacktriangleleft$ $\leftrightarrow$ Right $\blacktriangleright$ • Adjust to eliminate flicker.	✓	-	✓
H SIZE	<b>Adjustment:</b> Small $\blacktriangleleft$ $\leftrightarrow$ Large $\blacktriangleright$ • The image may not be displayed correctly if the horizontal size is excessive. In such cases, press the RESET button, and initialize the horizontal size.	✓	-	-
SHARPNESS	<b>Adjustment:</b> Soft $\blacktriangleleft$ $\leftrightarrow$ Clear $\blacktriangleright$	-	-	✓
COLOR	<b>Adjustment:</b> Light $\blacktriangleleft$ $\leftrightarrow$ Dark $\blacktriangleright$	-	-	✓
TINT	<b>Adjustment:</b> Red $\blacktriangleleft$ $\leftrightarrow$ Green $\blacktriangleright$ • Valid only when NTSC or NTSC 4.43 signal is received.	-	-	✓
COLOR BAL R	<b>Adjustment:</b> Light $\blacktriangleleft$ $\leftrightarrow$ Dark $\blacktriangleright$	✓	✓	✓
COLOR BAL B	<b>Adjustment:</b> Light $\blacktriangleleft$ $\leftrightarrow$ Dark $\blacktriangleright$	✓	✓	✓
ASPECT	<b>Select Image Aspect Ratio :</b> Full $\left[ \begin{array}{ c } \hline \square \\ \hline \end{array} \right] \blacktriangleleft \leftrightarrow \blacktriangleright 16:9 \left[ \begin{array}{ c } \hline \square \\ \hline \end{array} \right] \blacktriangleleft$	✓	✓	-
	<b>Select Position of Image:</b> Press the $\blacktriangledown$ button while 16:9 $\left[ \begin{array}{ c } \hline \square \\ \hline \end{array} \right]$ is selected. Center $\rightarrow$ $\blacktriangledown$ Down $\rightarrow$ $\blacktriangledown$ Up ( $\rightarrow$ Center $\blacktriangledown$ )			
	<b>Select Image Aspect Ratio:</b> 4:3 $\left[ \begin{array}{ c } \hline \square \\ \hline \end{array} \right] \blacktriangleleft \leftrightarrow \blacktriangleright 16:9 \left[ \begin{array}{ c } \hline \square \\ \hline \end{array} \right] \blacktriangleleft \leftrightarrow \blacktriangleright 4:3 \text{ small} \left[ \begin{array}{ c } \hline \square \\ \hline \end{array} \right]$			
	<b>Select Position of Image :</b> Press the $\blacktriangledown$ button while 16:9 $\left[ \begin{array}{ c } \hline \square \\ \hline \end{array} \right]$ / 4:3 small $\left[ \begin{array}{ c } \hline \square \\ \hline \end{array} \right]$ is selected. Center $\rightarrow$ $\blacktriangledown$ Down $\rightarrow$ $\blacktriangledown$ Up ( $\rightarrow$ Center $\blacktriangledown$ ) • 4:3 small cannot be selected with the input of 720p or 1080i component. • 4:3 small may not be displayed correctly with some input signals.	-	-	✓

# OPERATIONS (continued)

## Input Menu

The following functions are available when INPUT is selected on the menu. Select an item with the **▲** and **▼** buttons, and start or stop operation with the **▶** and **◀** buttons. The function indicated (\*\*) are effective on video input mode only, not on RGB input mode, except in the P.IN P. window on RGB input mode.

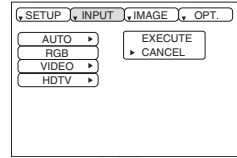

**Table 5. Input Menu**

Item	Description
AUTO	<p><b>Automatic Adjustment at RGB Input:</b> Select the EXECUTE with the <b>▲</b> button. Horizontal position (H.POSIT), vertical position (V.POSIT), clock phase (H.PHASE), and horizontal size (H.SIZE) are automatically adjusted. Use with the window at maximum size in the application display.</p> <p><b>Automatic Adjustment at Video Input:</b> Select the EXECUTE with the <b>▲</b> button. A signal type appropriate for the input signal is selected automatically when EXECUTE is selected automatically. Valid only when AUTO is set for VIDEO on the menu.</p> <ul style="list-style-type: none"> <li>• This operation requires approximately 10 seconds. It may not function correctly with some input signals. Pressing the AUTO button in this case may correct this problem.</li> <li>• This function is the same as for the AUTO function in Basic operation.</li> </ul>
RGB	<p><b>Displays RGB Input Frequency:</b> Displays the horizontal and vertical sync signal frequencies for RGB input.</p> <ul style="list-style-type: none"> <li>• Valid only at RGB input.</li> </ul>
VIDEO (**)	<p><b>Select Video Signal Type:</b> Select the signal type with the <b>▲</b> and <b>▼</b> buttons. Select NTSC, PAL, SECAM, NTSC4.43, M-PAL, or N-PAL as appropriate for the input signal. The selection of AUTO enables and executes the function AUTO (Automatic Adjustment at Video Input), except for the N-PAL input.</p> <ul style="list-style-type: none"> <li>• Use this function when the image becomes unstable (eg. the image becomes irregular, or lacks color) at VIDEO/S-VIDEO input.</li> <li>• Automatic Adjustment requires approximately 10 seconds. It may not function correctly with some input signals. Pressing the AUTO button in this case may correct this problem except for the N-PAL input.</li> <li>• For the COMPONENT VIDEO input, this function is not effective and the signal type is distinguished automatically. Refer to the item HDTV of the OPT. Menu for the signal of HDTV.</li> </ul>
HDTV	<p><b>Select HDTV mode:</b> Select the 1035i mode or 1080i mode suitable for the input signal with the <b>▲</b> / <b>▼</b> button.</p>



# OPERATIONS (continued)

## Image Menu

The following adjustments and settings are available when IMAGE is selected on the menu. Select an item with the **▲** and **▼** buttons, and start or stop operation with the **▶** and **◀** buttons.

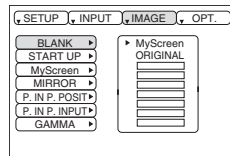

**Table 6. Image Menu**

Item	Description
BLANK	<p><b>Select Blank Screen:</b> Select the screen in case of the BLANK mode with the <b>▲</b>/<b>▼</b> button. The selected one (MyScreen, ORIGINAL or one colors) is displayed when the BLANK mode is ON.</p> <p><b>MyScreen</b> is a mode that the customer-customized screen is displayed. This is the blue screen at the factory setting. Refer to the description of MyScreen below.</p> <p><b>ORIGINAL</b> is a mode that the factory fixed screen is displayed.</p> <ul style="list-style-type: none"> <li>• When MyScreen or ORIGINAL is selected, the screen is going to the black after several minutes.</li> </ul>
START UP	<p><b>Select Start Up Screen:</b> Select the screen in case of no signal input with the <b>▲</b>/<b>▼</b> button. The selected one (MyScreen, ORIGINAL or TURN OFF) is displayed when no signal is input.</p> <p><b>My Screen</b> is a mode that the customer-customized screen is displayed. This is the blue screen at the factory setting. Refer to the description of MyScreen below.</p> <p><b>ORIGINAL</b> is a mode that the factory fixed screen is displayed.</p> <p><b>TURN OFF</b> displays the blue screen.</p> <ul style="list-style-type: none"> <li>• When MyScreen or ORIGINAL is selected, the screen is going to the black after several minutes.</li> </ul>
MyScreen	<p><b>Set MyScreen Mode:</b> Select the EXECUTE with the <b>▶</b> button to display the MyScreen menu and set the MyScreen mode for BLANK and START UP functions. <b>ESC</b> clears and closes the menu box.</p> <p><b>NORM.</b> is default of the MyScreen menu.</p> <p><b>FREEZE</b> freezes the image and displays the frame to capture. Press the <b>◀</b> button after freeze to go to the MyScreen Capture Position mode. <u>In the MyScreen Capture Position mode</u>, the buttons <b>◀</b>, <b>▶</b>, <b>▲</b> and <b>▼</b> allow to move the frame to capture. After adjusting the position, press the KEYSTONE button to go to the MyScreen Display Size mode. To cancel freezing and return to the NORM. of the MyScreen, press the RESET button.</p> <p><u>In the MyScreen Display Size mode</u>, select the magnification x1, x2 or FULL with the button <b>◀</b>/<b>▶</b>. After selecting the magnification, press the KEYSTONE button to go to the CAPT. mode and start capturing. To return to the MyScreen Capture Position mode, press the RESET button.</p> <p><b>CAPT.</b> executes a capturing the image. It requires about 20 seconds. After capturing, the captured image will be displayed for about 10 seconds.</p>
MIRROR	<p><b>Select Mirror Status:</b> Select mirror status with <b>▲</b> / <b>▼</b> button.</p>
P. IN P. POSIT	<p><b>Select Position of P. in P. Display :</b> Press the <b>▲</b> or <b>▼</b> button.</p> <p></p> <ul style="list-style-type: none"> <li>• P.IN P. function superimposes a video image over RGB or DVI signals.</li> </ul>
P. IN P. INPUT	<p><b>Select signal of P. in P. Display :</b> Press the <b>▲</b> or <b>▼</b> button.</p> <p>VIDEO <b>▲</b> ↔ <b>▼</b> S-VIDEO <b>▲</b></p>
GAMMA	<p><b>Select Gamma Mode:</b> Select the gamma mode with the <b>▲</b> / <b>▼</b> button.</p> <p>NORMAL <b>▲</b> ↔ <b>▼</b> CINEMA <b>▲</b> ↔ <b>▼</b> DYNAMIC</p>

# OPERATIONS (continued)

## Options Menu

The following adjustments and settings are available when OPT. is selected on the menu. Select an item with the **▲** and **▼** buttons, and start or stop operation with the **▶** and **◀** buttons.

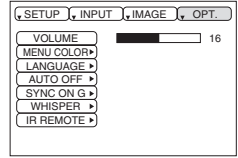
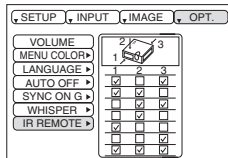

Table 7. Options Menu

Item	Description
VOLUME	Reduce <b>◀</b> ↔ <b>▶</b> Increase
MENU COLOR	<b>Select Menu Background Color:</b> Select with the <b>▶</b> / <b>◀</b> button.
LANGUAGE	<b>Select Menu Display Language:</b> Select with the <b>▲</b> / <b>▼</b> button.
AUTO OFF	<b>Set AUTO OFF:</b> Set 1~99 minutes with the <b>▲</b> / <b>▼</b> button. The system automatically enters the standby mode when a signal is not received for the set time. <b>Clear AUTO OFF:</b> Select STOP (0 min.) with the <b>▼</b> button. When STOP is selected the system does not enter the standby mode even if no signal is received.
SYNC ON G	<b>SYNC ON G Valid:</b> Select TURN ON with the <b>▲</b> button. <b>SYNC ON G Invalid:</b> Select TURN OFF with the <b>▼</b> button. • May not be displayed correctly with some input signals when SYNC ON G is valid. In such cases, remove the signal connector so that no signal is received, set SYNC ON G to invalid, and reconnect the signal.
WHISPER	<b>Set / Crear WHISPER Mode:</b> Press the <b>▲</b> / <b>▼</b> button. When the WHISPER is selected, the WHISPER mode is active. In the WHISPER mode, acoustic noise level from the unit is reduced, and brightness level on screen is a little lower.
IR REMOTE	<b>Select Remote Control Sensor:</b> Select the sensors to activate along the menu with the <b>▲</b> / <b>▼</b> button. Use this function if the remote does not work stably. The ambient light may affect the remote. • Strong light and obstacles will interfere with operation of the remote control transmitter.



: active  
 : inactive

# OPERATIONS (continued)

## No Signal Menu

The same adjustments and settings are available with the Image and Options menus when the MENU button is pressed during display of the “NO INPUT IS DETECTED ON \*\*\*” or “SYNC IS OUT OF RANGE ON \*\*\*” message while no signal is received. Select an item with the  $\blacktriangle$  and  $\blacktriangledown$  buttons, and start or stop operation with the  $\blacktriangleright$  and  $\blacktriangleleft$  buttons.

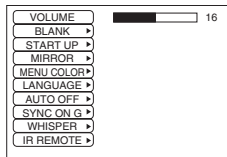

**Table 8. No Signal Menu**

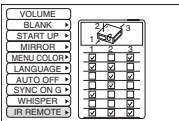
Item	Description
VOLUME	Reduce $\blacktriangleleft$ $\leftrightarrow$ $\blacktriangleright$ Increase <ul style="list-style-type: none"> <li>When this function is used, audio input is automatically switched to video. The audio input can be switched by moving the DISK PAD left and right during the display of the volume adjustment bar. The volume adjustment bar is displayed by pressing VOLUME <math>\blacktriangle</math> / <math>\blacktriangledown</math> button.</li> </ul>
BLANK	<b>Select Blank Screen:</b> Select the screen in case of the BLANK mode with the $\blacktriangle$ / $\blacktriangledown$ button. The selected one (MyScreen, ORIGINAL or one colors) is displayed when the BLANK mode is ON. <b>MyScreen</b> is a mode that the customer-customized screen is displayed. This is the blue screen at the factory setting. Refer to the description of MyScreen below. <b>ORIGINAL</b> is a mode that the factory fixed screen is displayed. <ul style="list-style-type: none"> <li>When MyScreen or ORIGINAL is selected, the screen is going to the black after several minutes.</li> </ul>
START UP	<b>Select Start Up Screen:</b> Select the screen in case of no signal input with the $\blacktriangle$ / $\blacktriangledown$ button. The selected one (MyScreen, ORIGINAL or TURN OFF) is displayed when no signal is input. <b>My Screen</b> is a mode that the customer-customized screen is displayed. This is the blue screen at the factory setting. Refer to the description of MyScreen below. <b>ORIGINAL</b> is a mode that the factory fixed screen is displayed. <b>TURN OFF</b> displays the blue screen. <ul style="list-style-type: none"> <li>When MyScreen or ORIGINAL is selected, the screen is going to the black after several minutes.</li> </ul>
MIRROR	<b>Select Mirror Status:</b> Select the mirror status with the $\blacktriangle$ / $\blacktriangledown$ button.
MENU COLOR	<b>Select Menu Background Color:</b> Select the color with the $\blacktriangleright$ / $\blacktriangleleft$ button.
LANGUAGE	<b>Select Menu Display Language:</b> Select the language with the $\blacktriangle$ / $\blacktriangledown$ button.
AUTO OFF	<b>Set AUTO OFF:</b> Set 1~99 minutes with the $\blacktriangle$ / $\blacktriangledown$ button. The system automatically enters the standby mode when a signal is not received for the set time. <b>Clear AUTO OFF:</b> Select the STOP (0 min.) with the $\blacktriangledown$ button. When the STOP is selected the system does not enter the standby mode even if no signal is received.
SYNC ON G	<b>SYNC ON G Valid:</b> Select the TURN ON with the $\blacktriangle$ button. <b>SYNC ON G Invalid:</b> Select the TURN OFF with the $\blacktriangledown$ button. <ul style="list-style-type: none"> <li>May not be displayed correctly with some input signals when the SYNC ON G is valid. In such cases, remove the signal connector so that no signal is received, set the SYNC ON G to invalid, and reconnect the signal.</li> </ul>
WHISPER	<b>Set / Crear WHISPER Mode:</b> Press the $\blacktriangle$ / $\blacktriangledown$ button. When the WHISPER is selected, the WHISPER mode is active. In the WHISPER mode, acoustic noise level from the unit is reduced, and brightness level on screen is a little lower.
IR REMOTE	<b>Select Remote Control Sensor:</b> Select the sensors to activate along the menu with the $\blacktriangle$ / $\blacktriangledown$ button. Use this function if the remote does not work stably. The ambient light may affect the remote. 

# MAINTENANCE

## Lamp



**HIGH VOLTAGE  
HIGH TEMPERATURE  
HIGH PRESSURE**

Contact your dealer before replacing the lamp.

For the optional lamp, see the item “Optional Parts” of the Table 12.

Before replacing the lamp, switch power OFF, remove the power cord from the power outlet, and wait approximately 45 minutes until the lamp has cooled. The lamp may explode if handled at high temperatures.



**WARNING** A mercury lamp used in this LCD projector is made of glass and has high internal pressure. The mercury lamp can burst with a big noise due to deterioration resulting from a shock, crack and passage of time, and can end its service life in unlit condition. Lamps also have a considerably different service life and can sometimes end up in burst or turn to unlit condition soon after use. Furthermore, when the lamp is blown up, glass fragments can get scattered around the lamp house and some gas containing mercury inside the lamp can leak out of the projector’s air vent.

- Handle the lamp with utmost care as it can burst during use if subjected to a shock or impact or if scratched or cracked.
- Probability for the burst will increase if the lamp is used for extended period of time or used exceeding the period of replacement. You are advised to follow instructions for lamp replacement as soon as they are given (Refer to Table 9 of Page 20, Table 10 of Page 21). Avoid any reuse of an old lamp (used lamp) since such reuse can result in burst.
- In case the lamp gets blown up in a short period of time after use, some electrical failures or troubles other than the lamp itself may be suspected as causes. Under such circumstances, consult the store where you purchased it or a service company.
- Should the lamp burst (accompanied by a big bursting noise), perform ventilation sufficiently, and exercise maximum caution not to inhale any gas out of the projector’s air vent or not to let it enter your eyes or mouth.
- Should the lamp burst (accompanied by a big bursting noise), make absolutely sure to unplug the power cord from the outlet and ask the store where you bought the lamp for immediate replacement. You should not engage in cleanup or replacement of the lamp by yourself since scattered glass fragments can damage the inside of projector or can result in personal injury when you handle it.
- When you dispose of any used lamps, be sure to observe and follow local ordinances and regulations of the area or district where they are subjected to disposal. Generally speaking, the lamps are treated similarly as glasses and bottles in most cases, but there are areas or districts where lamps are classified as a separate collection, and so be sure to use caution.
- Never use the lamp in a state where the lamp cover is removed.

## Lamp Life

Projector lamps have a finite life. The image will become darker, and hues will become weaker, after a lamp has been used for a long period of time.

Replace the lamp if the LAMP indicator is red, or the CHANGE THE LAMP message appears when the projector is switched ON. See Table 9 of P.20 and Table 10 of P.21.

**NOTE** • The LAMP indicator is also red when the lamp unit reaches high temperature. Before replacing the lamp, switch power OFF, wait approximately 20 minutes, and switch power ON again. If the LAMP indicator is still red, replace the lamp.

# MAINTENANCE (continued)

## Replacing the Lamp

1. Switch the projector OFF, remove the power cord from the power outlet, and wait at least 45 minutes for the unit to cool.
2. Prepare a new lamp.
3. Check that the projector has cooled sufficiently, and gently turn it upside down.
4. Loosen the two screws as shown in the diagram, and remove the lamp cover.
5. Loosen the three screws, and gently remove the lamp while holding the grips. Touching the inside of the lamp case may result in uneven coloring.
6. Install the new lamp and tighten the three screws firmly. Also steadily push the opposite side of the screwed lamp into the unit.
7. Replace the lamp cover in position and tighten the two screws firmly.
8. Gently turn the projector right-side up.

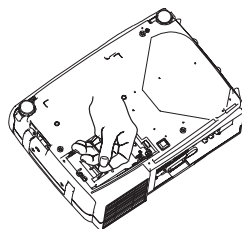
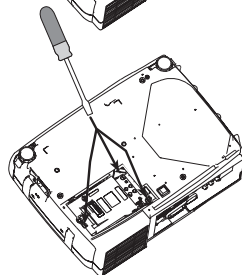
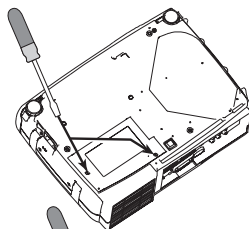

**CAUTION** • Ensure that screws are tightened properly. Screws not tightened fully may result in injury or accidents.

• Do not use the projector with the lamp cover removed.

## Resetting the Lamp Timer

Reset the lamp timer after replacing the lamp. When the lamp has been replaced after the LAMP indicator is red, or the CHANGE THE LAMP message is displayed, complete the following operation within ten minutes of switching power ON. The power will be turned off automatically in over 10 minutes.

1. Switch power ON, and press the RESET button, for approximately three seconds. The 'LAMP xxxx hr' message will appear on the lamp timer on the bottom of the screen.
2. Press the MENU button on the remote control transmitter, or the RESET button on the control panel, while the lamp timer is displayed. The 'LAMP xxxx □ → 0 ■ CANCEL' message will then appear.
3. Press the  and select 0, and wait until the timer display is cleared.

**NOTE** • Do not reset the lamp timer without replacing the lamp. Reset the lamp timer always when replacing the lamp. The message functions will not operate properly if the lamp timer is not reset correctly.

# MAINTENANCE (continued)

## Air Filter

### Cleaning the air Filter

The air filter should be cleaned as described below at intervals of approximately 100 hours.

1. Switch the projector power supply OFF, and remove the power cord from the power outlet.
2. Clean the air filter with a vacuum cleaner.

### Replacing the Air Filter

Replace the air filter if contamination cannot be removed, or if it is damaged.

1. Remove the filter cover.
2. Remove the old filter.
3. Set the new filter and the filter cover.



**CAUTION** • Switch power OFF and remove the power cord from the power outlet before beginning maintenance work. Please read the separate “SAFETY INSTRUCTIONS” thoroughly to ensure that maintenance is performed correctly.

- Replace the air filter if contamination cannot be removed, or if it is damaged. Contact your dealer in such case. For the optional air filter, see the item “Optional Parts” of the Table 12.
- Do not use the equipment with the air filter removed.
- When the air filter is clogged with dust etc. the power supply is switched OFF automatically to prevent the temperature rising inside the projector.

## Other Maintenance

### Maintenance Inside the Equipment

For safety reasons, ensure that the equipment is cleaned and checked by the dealer once every two years. Maintaining the equipment by yourself is dangerous.

### Cleaning the Lens

Gently wipe the lens with lens cleaning paper. Do not touch the lens with your hands.

### Cleaning the Cabinet and Remote control transmitter

Gently wipe with a soft cloth. If dirt and stains etc. are not easily removed, use a soft cloth dampened with water, or water and a neutral detergent, and wipe dry with a soft, dry cloth.



**CAUTION** • Switch power OFF and remove the power cord from the power outlet before beginning maintenance work. Please read the separate “SAFETY INSTRUCTIONS” thoroughly to ensure that maintenance is performed correctly.

- Do not use detergents or chemicals other than those noted above (e.g. benzene or thinners).
- Do not use cleaning sprays.
- Do not rub with hard materials, or tap the equipment.

**NOTE** • When this projector is brought into a warm room from a cold outdoor, condensation can take place on the projection lens and mirror inside, blurring the screen and reducing your eyesight, but do not worry. The condensation will disappear and the screen will return to a normal condition no sooner than the projector acclimates to the surrounding temperature.

# TROUBLESHOOTING

## OSD Message

The messages as described below may appear on the screen at power ON. Take the appropriate measures when such messages appears.

**Table 9. OSD Message**

Message	Contents
CHANGE THE LAMP AFTER REPLACING LAMP, RESET THE LAMP TIME. (*1)	The usage time of lamp will be reaching 2000 hr shortly.(*2) It is recommended to replace the lamp soon. Prepare a new lamp as a replacement.
CHANGE THE LAMP AFTER REPLACING LAMP, RESET THE LAMP TIME. THE POWER WILL TURN OFF AFTER ** hr. (*1)	The usage time of lamp will be reaching 2000 hr shortly. It is recommended to replace the lamp within * * hours.(*2) It might be happened that the lamp is cut off before * * hr by any chance. Power will be switched OFF automatically in * * hours. Replace the lamp as shown in P.17~18 "Lamp". Always reset the lamp timer after replacing the lamp.
CHANGE THE LAMP AFTER REPLACING LAMP, RESET THE LAMP TIME. THE POWER WILL TURN OFF AFTER 0 hr.	The usage time of lamp is about to reach. Power will be switched OFF in a few minutes.(*2) Switch power OFF immediately and replace the lamp as shown in P.17 ~18 "Lamp". Always reset the lamp timer after replacing the lamp.
NO INPUT IS DETECTED ON ***	No input signal found. Check signal input connections and signal sources.
SYNC IS OUT OF RANGE ON ***	The horizontal or vertical frequency of the input signal is not within the specified range. Check the specifications of the equipment and the signal source.
CHECK THE AIR FLOW	The internal temperature has risen. Switch power OFF, and wait 20 minutes until the equipment cools. Check the following and Switch power ON again. * Are the ventilation openings blocked. * Is the air filter dirty. * Is the ambient temperature in excess of 35°C.

**NOTE** (\*1) This message is cleared automatically after approximately three minutes, and appears every time power is switched ON.

(\*2) The unit has a function to turn the power off which will be active when the usage time reaches 2000 hr. However the life of lamp might be much different among lamps, so that it might be happened that a lamp is cut off before the function is active.

# TROUBLESHOOTING (continued)

## Indicators Message

The POWER indicator, LAMP indicator, and TEMP indicator are lit and blank as follows. Take the appropriate measures.

Table 10. Indicators Message

POWER indicator	LAMP indicator	TEMP indicator	Contents
Lights orange	Turns off	Turns off	The Standby mode has been set.
Blinks green	Turns off	Turns off	Warming up. Please wait.
Lights green	Turns off	Turns off	ON. Normal operation possible.
Blinks orange	Turns off	Turns off	Cooling. Please wait.
Blinks red	-	-	Cooling. Please wait. The error is found. Take the appropriate measures when the POWER indicator ceases blinking
Blinks /Lights red	Lights red	Turns off	Lamp is not lit. The interior of the equipment may be too hot. Switch power OFF, wait 20 minutes until the equipment cools, and check whether the ventilation openings are blocked, whether the air filter is dirty, or whether the ambient temperature exceeds 35 °C. And switch power ON again. Replace the lamp if the same problem occurs.
Blinks /Lights red	Blinks red	Turns off	Lamp or lamp cover is not found, or hasn't been fitted in correctly. Switch power OFF, and wait for 45 minutes until the equipment cools. Check fitting of the lamp and lamp cover, and switch power ON again. Contact your dealer if the same problem occurs again.
Blinks /Lights red	Turns off	Blinks red	The cooling fan is not operating. Switch power OFF, and wait for 20 minutes until the equipment cools. Check for foreign matters in the fan, and switch power ON again. Contact your dealer if the same problem occurs again.
Blinks /Lights red	Turns off	Lights red	The interior of the equipment is too hot. Switch power OFF, and wait for 20 minutes until the equipment cools. Check whether the ventilation openings are blocked, whether the air filter is dirty, or whether the ambient temperature exceeds 35 °C. Then switch power ON again. Contact your dealer if the same problem occurs again.
Lights green	Blinks red	Blinks red	The interior of the equipment is too cool. Check whether the ambient temperature is below 0°C. Contact your dealer if the same problem occurs when the ambient temperature is 0~35°C.

**NOTE** When the internal temperature becomes excessive power is switched OFF automatically for safety reasons, and the indicator is extinguished. Set the power switch to [O] and wait for 20 minutes until the equipment has cooled sufficiently.





# TROUBLESHOOTING (continued)

## Symptom

Before requesting repair, check in accordance with the following chart. If the situation cannot be corrected, then contact your dealer.

**Table 11. Symptom**

Symptom	Possible cause	Remedy	Page
The power is not turned on.	The main power switch is not turned on.	Turn on the main power switch.	8,9
	The power cord is disconnected.	Plug the power cord into an AC power outlet.	
	The main power was disconnected during operation by the power failure and so on.	Turn off the projector with the main power switch (set the power switch to [O]), and wait for about 20 minutes. When the equipment has cooled enough, turn power on.	9
No video or audio.	The input is not correctly set.	Use the projector or remote control	10
	No signal input.	Connect correctly.	7,8
Video is present but no audio.	The projector is not correctly connected.	Connect correctly.	7,8
	The volume is set to minimum.	Press VOLUME  on the remote control or display the menu screen and adjust the volume.	11,15
	Mute is turned on.	Press the MUTE  button.	11
Audio is present but no video.	The projector is not correctly connected.	Connect correctly.	7,8
	The brightness adjustment knob is rotated fully clockwise.	Select BRIGHT with the MENU button and the press the  button.	12
	The lens cap is still attached.	Remove the lens cap.	9
Colors are pale and color matching is	Color density and color matching are not correctly	Adjust the video.	12
Images are dark.	Brightness and contrast are not correctly adjusted.	Adjust the video.	12
	The lamp is nearing the end of its service life.	Replace with a new lamp.	17
	WHISPER mode is set.	Clear WHISPER mode.	15
Video is blurred.	Focus or H PHASE is out of adjustment.	Adjust the focus or H PHASE.	9,12

# SPECIFICATIONS

**Table 12. Specifications**

Item		Specification	
Product name		Liquid crystal projector	
Liquid crystal panel	Panel size	2.3 cm (0.9 type)	
	Drive system	TFT active matrix	
	Pixels	CP-X430:786,432 pixels (1024 horizontal x 768 vertical) CP-S420:480,000 pixels (800 horizontal x 600 vertical)	
Lens		Zoom lens F=1.7 ~ 2.1 f=36.8 ~ 47.8 mm	
Lamp		250 W UHB	
Speaker		1.0W+1.0W (stereo)	
Power supply		AC100 ~ 120V, 4.5A / AC220 ~ 240V, 1.9A	
Power consumption		410W	
Temperature range		0 ~ 35°C (Operating)	
Size		360 (W) x 106 (H) x 256.5 (D) mm	
Weight (mass)		4.5 kg	
RGB signal input	RGB IN	1	Video: Analog 0.7Vp-p, 75Ω terminator (positive) H/V. sync.: TTL level (positive/negative) Composite sync.: TTL level D-sub 15-pin shrink jack
		2	D-sub 15-pin shrink jack
	DVI (CP-X430 only)		TMDS, DC: 150~1200 mV / AC: 1.56 Vp-p TTL Level (Positive/Negative)
	AUDIO IN	RGB1	200mVrms, 50 kΩ (max. 3.0Vp-p) Stereo mini jack
		DVI (CP-X430 only)	
RGB2			
Video signal input	VIDEO IN		1.0Vp-p, 75Ω terminator RCA jack
	S-VIDEO IN		Brightness signal: 1.0Vp-p, 75Ω terminator Color signal: 0.286Vp-p (NTSC, burst signal), 75Ω terminator 0.300Vp-p (PAL/SECAM, burst signal), 75Ω terminator Mini DIN 4-pin jack
	COMPONENT VIDEO	Y	1.0 Vp-p, 75 Ω Terminator (Positive)
		Cb/Pb	0.7 Vp-p, 75 Ω Terminator (Positive)
		Cr/Pr	0.7 Vp-p, 75 Ω Terminator (Positive)
	AUDIO IN	L	200mVrms, 50 kΩ (max. 3.0Vp-p) RCA jack
		R	
Signal output	RGB OUT		Video: Analog 0.7Vp-p, 75Ω output impedance (positive) H/V. sync.: TTL level (positive/negative) Composite sync.: TTL level D-sub 15-pin shrink jack
	AUDIO OUT		200mVrms, output impedance 1 kΩ (max. 3.0Vp-p) Stereo mini jack
Control functions	CONTROL		D-sub 15-pin shrink plug
	USB		USB jack (B type)
Optional Parts		Lamp: DT00471 Air Filter: NJ06131 * For others, consult your dealer.	

**NOTE** • This specifications are subject to change without notice.

# **WARRANTY AND AFTER-SERVICE**

---

If a problem occurs with the equipment, first refer to the P.20 “TROUBLESHOOTING” section and run through the suggested checks. If this does not resolve the problem contact your dealer or service company. They will tell you what warranty condition is applied.

# TECHNICAL

## Dimension Diagram

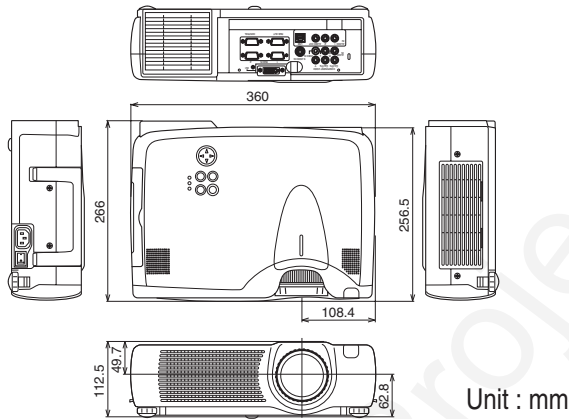

## Signal Connector Pin Assignment

### 1. D-sub 15-pin Shrink Connector (RGB IN 1/RGB IN 2/RGB OUT)

Pin No	Signal	Pin No	Signal	Pin No	Signal
1	Video input Red	9	-	15	RGB IN 1: SCL(DDC)
2	Video input Green	10	Ground		RGB IN 2: -
3	Video input Blue	11	-		RGB OUT: -
4	-	12	RGB IN 1: SDA(DDC)		
5	Ground		RGB IN 2: -		
6	Ground Red		RGB OUT: -		
7	Ground Green	13	H. sync./ Composite sync.		
8	Ground Blue	14	Vertical sync		

### 2. Digital Receptacle Connector (DVI) (\*CP-X430 only)

Pin No	Signal	Pin No	Signal	Pin No	Signal
1	T.M.D.S. Data 2 -	11	T.M.D.S. Data 1 / 3 Shield	21	-
2	T.M.D.S. Data 2 +	12	-	22	T.M.D.S. Clock Shield
3	T.M.D.S. Data 2 / 4 Shield	13	-	23	T.M.D.S. Clock +
4	-	14	+5V Power	24	T.M.D.S. Clock -
5	-	15	Ground (+5V, Analog H/V Sync.)		
6	DDC Clock	16	Hot-Plug Sense		
7	DDC Data	17	T.M.D.S. Data 0 -		
8	Analog V. Sync.	18	T.M.D.S. Data 0 +		
9	T.M.D.S. Data 1 -	19	T.M.D.S. Data 0 / 5 Shield		
10	T.M.D.S. Data 1 +	20	-		

### 3. Mini Din 4-pin Connector (S-VIDEO)

Pin No	Signal
1	Color:0.286Vp-p (NTSC, burst signal),75Ω terminator 0.300Vp-p (PAL/SECAM, burst signal),75Ω terminator
2	Brightness:1.0Vp-p, 75Ω terminator
3	Ground
4	Ground

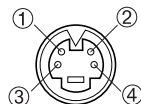

# TECHNICAL (continued)

## Example of computer signal

Resolution H x V	fH (kHz)	fV (Hz)	Rating	Signal mode	Display mode	
					CP-S420	CP-X430
640 x 350	37.9	85.1	VESA	VGA-1	Zoom in	Zoom in
640 x 400	37.9	85.1	VESA	VGA-2	Zoom in	Zoom in
720 x 400	37.9	85.0	VESA	TEXT	Zoom in	Zoom in
640 x 480	31.5	59.9	VESA	VGA (60Hz)	Zoom in	Zoom in
640 x 480	35.0	66.7		Mac13"mode	Zoom in	Zoom in
640 x 480	37.9	72.8	VESA	VGA (72Hz)	Zoom in	Zoom in
640 x 480	37.5	75.0	VESA	VGA (75Hz)	Zoom in	Zoom in
640 x 480	43.3	85.0	VESA	VGA (85Hz)	Zoom in	Zoom in
800 x 600	35.2	56.3	VESA	SVGA (56Hz)		Zoom in
800 x 600	37.9	60.3	VESA	SVGA (60Hz)		Zoom in
800 x 600	48.1	72.2	VESA	SVGA (72Hz)		Zoom in
800 x 600	46.9	75.0	VESA	SVGA (75Hz)		Zoom in
800 x 600	53.7	85.1	VESA	SVGA (85Hz)		Zoom in
832 x 624	49.7	74.5		Mac16"mode	Zoom out	
1024 x 768	48.4	60.0	VESA	XGA (60Hz)	Zoom out	
1024 x 768	56.5	70.1	VESA	XGA (70Hz)	Zoom out	
1024 x 768	60.0	75.0	VESA	XGA (75Hz)	Zoom out	
1024 x 768	68.7	85.0	VESA	XGA (85Hz)	Zoom out	
1152 x 864	67.5	75.0	VESA	SXGA (75Hz)	Zoom out	Zoom out
1280 x 960	60.0	60.0	VESA	SXGA (60Hz)	Zoom out	Zoom out
1280 x 1024	64.0	60.0	VESA	SXGA (60Hz)	Zoom out	Zoom out
1280 x 1024	80.0	75.0	VESA	SXGA (75Hz)	Zoom out	Zoom out

**NOTE** • Some computers may have multiple display screen modes. Use of some of these modes will not be possible with this projector.

- Be sure to check jack type, signal level, timing and resolution before connecting this projector to a computer.
- Depending on the input signal, full-size display may not be possible in some cases. Refer to the number of display pixels above.
- The image may not be displayed correctly when the input sync. signal is "Composite Sync." or "Sync. on G".
- The image might be something wrong with computer by computer on the DVI mode. In the case, it is recommended to reduce the resolution and / or refresh rate.(CP-X430 only)

# TECHNICAL (continued)

## Initial set signals

The following signals are used for the initial settings.

The signal timing of some computer models may be different. In such case, refer to adjust the V.POSIT and H.POSIT of the menu.

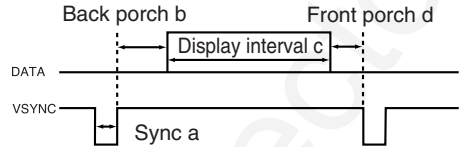
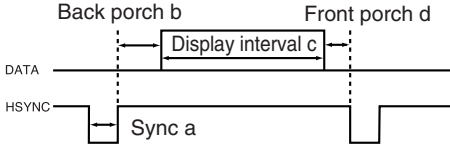

Computer / Signal	Horizontal signal timing (μs)				Computer / Signal	Vertical signal timing (lines)			
	a	b	c	d		a	b	c	d
VGA-1 (85Hz)	2.0	3.0	20.3	1.0	VGA-1 (85Hz)	3	60	350	32
VGA-2 (85Hz)	2.0	3.0	20.3	1.0	VGA-2 (85Hz)	3	41	400	1
TEXT	2.0	3.0	20.3	1.0	TEXT	3	42	480	1
VGA (60Hz)	3.8	1.9	25.4	0.6	VGA (60Hz)	2	33	480	10
Mac 13"mode	2.1	3.2	21.2	2.1	Mac 13"mode	3	39	480	3
VGA (72Hz)	1.3	3.8	20.3	1.0	VGA (72Hz)	3	28	480	9
VGA (75Hz)	2.0	3.8	20.3	0.5	VGA (75Hz)	3	16	480	1
VGA (85Hz)	1.6	2.2	17.8	1.6	VGA (85Hz)	3	25	480	1
SVGA (56Hz)	2.0	3.6	22.2	0.7	SVGA (56Hz)	2	22	600	1
SVGA (60Hz)	3.2	2.2	20.0	1.0	SVGA (60Hz)	4	23	600	1
SVGA (72Hz)	2.4	1.3	16.0	1.1	SVGA (72Hz)	6	23	600	37
SVGA (75Hz)	1.6	3.2	16.2	0.3	SVGA (75Hz)	3	21	600	1
SVGA (85Hz)	1.1	2.7	14.2	0.6	SVGA (85Hz)	3	27	600	1
Mac 16"mode	1.1	3.9	14.5	0.6	Mac 16"mode	3	39	624	1
XGA (60Hz)	2.1	2.5	15.8	0.4	XGA (60Hz)	6	29	768	3
XGA (70Hz)	1.8	1.9	13.7	0.3	XGA (70Hz)	6	29	768	3
XGA (75Hz)	1.2	2.2	13.0	0.2	XGA (75Hz)	3	28	768	1
XGA (85Hz)	1.0	2.2	10.8	0.5	XGA (85Hz)	3	36	768	1
1152x864 (75Hz)	1.2	2.4	10.7	0.6	1152x864 (75Hz)	3	32	864	1
1280x960 (60Hz)	1.0	2.9	11.9	0.9	1280x960 (60Hz)	3	36	960	1
1280x1024 (60Hz)	1.0	2.3	11.9	0.4	1280x1024 (60Hz)	3	38	1024	1
1280x1024 (75Hz)	1.1	1.8	9.5	0.1	1280x1024 (75Hz)	3	38	1024	1

# TECHNICAL (continued)

## Connection to the Mouse Control

### 1. PS/2, ADB or Serial Mouse

- (1) Turn off the projector and computer, and connect the two units with the appropriate cable. For PS/2 mouse control (for IBM and compatible), use the enclosed mouse cable. For others, consult your dealer.
- (2) Disconnect the USB cable from the projector if it is connected. Then turn on the projector.
- (3) Turn on the computer.
- (4) Start the mouse function. If the mouse has not been started, reboot the computer (soft reboot or reboot buttons). Refer to the descriptions of “DISC PAD” and “MOUSE/RIGHT button” of page 4.

### 2. USB Mouse

- (1) Connect the projector and computer with a suitable commercially available USB cable. Consult your dealer to get the cable, if you need.
- (2) Start the mouse function. Refer to the descriptions of “DISC PAD” and “MOUSE/RIGHT button” of page 4.

**NOTE** • Before connecting, read the instruction manuals of the devices to be connected.  
• In the case of notebook type computers with an internal pointing device, the mouse control function will not work unless the internal pointing device is disabled. In such case, disable the internal pointing device and change the BIOS setting to select an external mouse before the operations described in (1) to (4) above.

Also, some computers may not have a utility program to operate a mouse.  
Refer to the computer hardware manual for detail.

### PS/2 Mouse

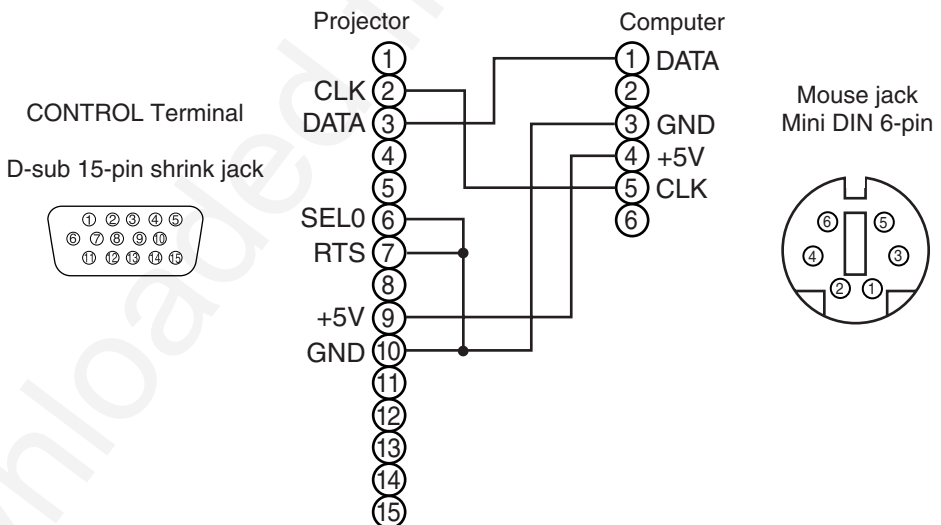

# TECHNICAL (continued)

## ADB Mouse

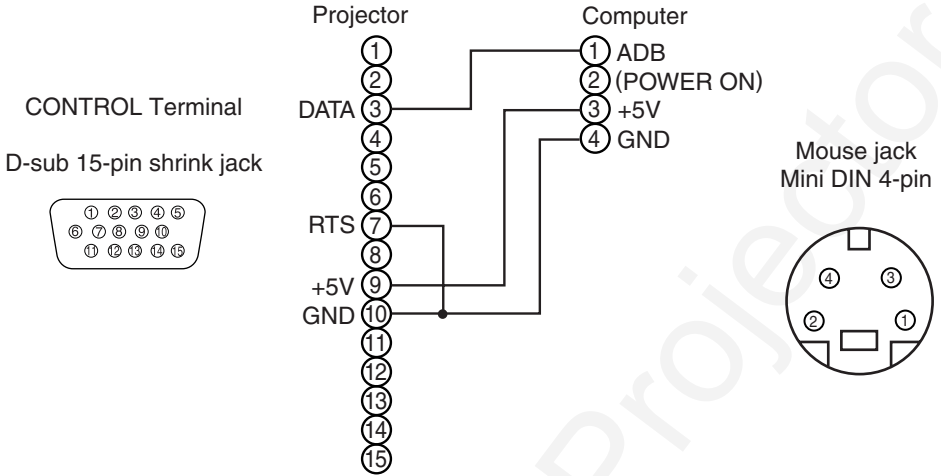

## Serial Mouse

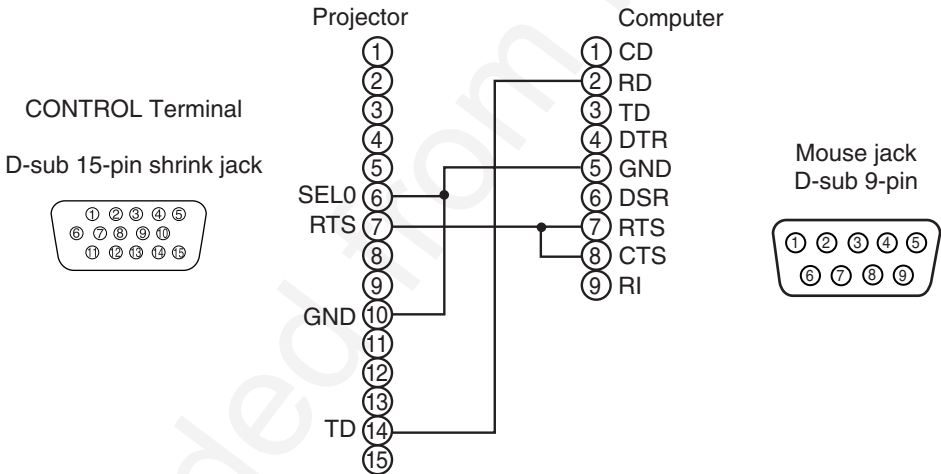

## USB Mouse

USB jack  
(B type)

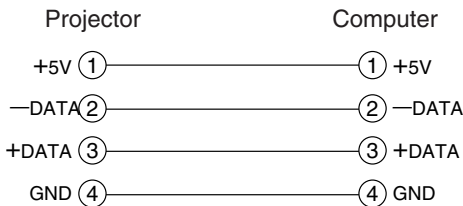
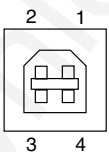

USB cable

USB jack  
(A type)

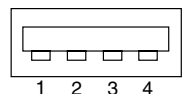



# TECHNICAL (continued)

## RS-232C communication

- (1) Turn off the projector and computer power supplies and connect with the RS-232C cable.
- (2) Turn on the computer power supply and, after the computer has started up, turn on the projector power supply.

Control jack  
D-sub 15-pin shrink jack

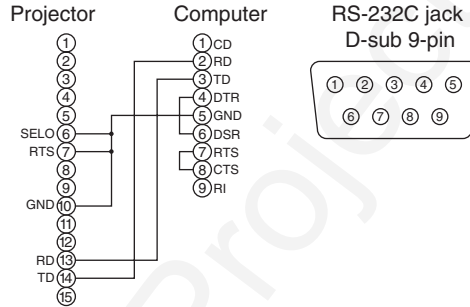
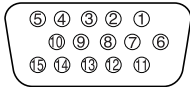

## Communications setting

19200bps, 8N1

### 1 Protocol

Consist of header (7 bytes) + command data (6 bytes).

### 2 Header

BE + EF + 03 + 06 + 00 + CRC\_low + CRC\_high

CRC\_low : Lower byte of CRC flag for command data.

CRC\_high : Upper byte of CRC flag for command data.

### 3 Command data

Command data chart

byte_0	byte_1	byte_2	byte_3	byte_4	byte_5
Action		Type		Setting code	
low	high	low	high	low	high

Action (byte\_0 - 1)

Action	Classification	Content
1	SET	Change setting to desired value.
2	GET	Read projector internal setup value.
4	INCREMENT	Increment setup value by 1.
5	DECREMENT	Decrement setup value by 1.
6	EXECUTE	Run a command.

# TECHNICAL (continued)

---

## Requesting projector status (Get command)

- (1) Send the request code Header + Command data ('02H'+ '00H'+ type (2 bytes) + '00H'+ '00H') from the computer to the projector.
- (2) The projector returns the response code '1DH'+ data (2 bytes) to the computer.

## Changing the projector settings (Set command)

- (1) Send the setting code Header + Command data ('01H'+ '00H'+ type (2 bytes) + setting code (2 bytes)) from the computer to the projector.
- (2) The projector changes the setting based on the above setting code.
- (3) The projector returns the response code '06H' to the computer.

## Using the projector default settings (Reset Command)

- (1) The computer sends the default setting code Header + Command data ('06H'+ '00H'+ type (2 bytes) + '00H'+ '00H') to the projector.
- (2) The projector changes the specified setting to the default value.
- (3) The projector returns the response code '06H' to the computer.

## Increasing the projector setting value (Increment command)

- (1) The computer sends the increment code Header + Command data ('04H'+ '00H'+ type (2 bytes) + '00H'+ '00H') to the projector.
- (2) The projector increases the setting value on the above setting code.
- (3) The projector returns the response code '06H' to the computer.

## Decreasing the projector setting value (Decrement command)

- (1) The computer sends the decrement code Header + Command data ('05H'+ '00H'+ type (2 bytes) + '00H'+ '00H') to the projector.
- (2) The projector decreases the setting value on the above setting code.
- (3) The projector returns the response code '06H' to the computer.

## When a command sent by the projector cannot be understood by the computer

When the command sent by the projector cannot be understood, the error command '15H' is returned by the computer. Some times, the projector ignores RS-232C commands during other works. If the error command '15H' is returned, please send the same command again.

## When data sent by the projector cannot be practice

When the command sent by the projector cannot be practiced, the the error code '1cH' + 'xxxxH' is returned.

When the data length is greater than indicated by the data length code, the projector will ignore the excess data code.

Conversely, when the data length is shorter than indicated by the data length code, an error code will be returned to the projector.

**NOTE** • Operation cannot be guaranteed when the projector receives an undefined command or data.

- Provide an interval of at least 40ms between the response code and any other code.
- The projector outputs test data when the power supply is switched ON, and when the lamp is lit. Ignore this data.
- Commands are not accepted during warm-up.

# TECHNICAL (continued)

Command data chart

Names	Operation type		Header				Command data			
							CRC	Action	Type	Setting code
Blank Color	Set	Red	BE EF	03 06 00	3B D3	01 00	00 30	00 00		
		Orange	BE EF	03 06 00	AB D2	01 00	00 30	01 00		
		Green	BE EF	03 06 00	5B D2	01 00	00 30	02 00		
		Blue	BE EF	03 06 00	CB D3	01 00	00 30	03 00		
		Purple	BE EF	03 06 00	FB D1	01 00	00 30	04 00		
		White	BE EF	03 06 00	6B D0	01 00	00 30	05 00		
		Black	BE EF	03 06 00	9B D0	01 00	00 30	06 00		
		MyScreen	BE EF	03 06 00	FB CA	01 00	00 30	20 00		
	ORIGNAL	BE EF	03 06 00	FB E2	01 00	00 30	40 00			
	Get	BE EF	03 06 00	08 D3	02 00	00 30	00 00			
Mirror	Set	Normal	BE EF	03 06 00	C7 D2	01 00	01 30	00 00		
		H Inverse	BE EF	03 06 00	57 D3	01 00	01 30	01 00		
		V Inverse	BE EF	03 06 00	A7 D3	01 00	01 30	02 00		
		H&V Inverse	BE EF	03 06 00	37 D2	01 00	01 30	03 00		
		Get	BE EF	03 06 00	F4 D2	02 00	01 30	00 00		
Freeze	Set	Normal	BE EF	03 06 00	83 D2	01 00	02 30	00 00		
		Freeze	BE EF	03 06 00	13 D3	01 00	02 30	01 00		
		Get	BE EF	03 06 00	B0 D2	02 00	02 30	00 00		
Menu Color	Set	Red	BE EF	03 06 00	7F D3	01 00	03 30	00 00		
		Orange	BE EF	03 06 00	EF D2	01 00	03 30	01 00		
		Green	BE EF	03 06 00	1F D2	01 00	03 30	02 00		
		Blue	BE EF	03 06 00	8F D3	01 00	03 30	03 00		
		Purple	BE EF	03 06 00	BF D1	01 00	03 30	04 00		
		Transparent	BE EF	03 06 00	2F D0	01 00	03 30	05 00		
		Gray	BE EF	03 06 00	DF D0	01 00	03 30	06 00		
		Get	BE EF	03 06 00	4C D3	02 00	03 30	00 00		
Startup	Set	ORIGNAL	BE EF	03 06 00	0B D2	01 00	04 30	00 00		
		OFF	BE EF	03 06 00	9B D3	01 00	04 30	01 00		
		MyScreen	BE EF	03 06 00	CB CB	01 00	04 30	20 00		
		Get	BE EF	03 06 00	38 D2	02 00	04 30	00 00		
Language	Set	English	BE EF	03 06 00	F7 D3	01 00	05 30	00 00		
		Français	BE EF	03 06 00	67 D2	01 00	05 30	01 00		
		Deutsch	BE EF	03 06 00	97 D2	01 00	05 30	02 00		
		Español	BE EF	03 06 00	07 D3	01 00	05 30	03 00		
		Italiano	BE EF	03 06 00	37 D1	01 00	05 30	04 00		
		Norsk	BE EF	03 06 00	A7 D0	01 00	05 30	05 00		
		Nederlands	BE EF	03 06 00	57 D0	01 00	05 30	06 00		
		Português	BE EF	03 06 00	C7 D1	01 00	05 30	07 00		
		Japanese	BE EF	03 06 00	37 D4	01 00	05 30	08 00		
		Get	BE EF	03 06 00	C4 D3	02 00	05 30	00 00		

# TECHNICAL (continued)

## Command data chart

Names	Operation type		Header				Command data		
						CRC	Action	Type	Setting code
Magnify	Get		BE EF	03 06	00 7C	D2	02 00	07 30	00 00
	Increment		BE EF	03 06	00 1A	D2	04 00	07 30	00 00
	Decrement		BE EF	03 06	00 CB	D3	05 00	07 30	00 00
Auto off	Get		BE EF	03 06	00 08	86	02 00	10 31	00 00
	Increment		BE EF	03 06	00 6E	86	04 00	10 31	00 00
	Decrement		BE EF	03 06	00 BF	87	05 00	10 31	00 00
Brightness Reset	Execute		BE EF	03 06	00 58	D3	06 00	00 70	00 00
Contrast Reset	Execute		BE EF	03 06	00 A4	D2	06 00	01 70	00 00
V.Position Reset	Execute		BE EF	03 06	00 E0	D2	06 00	02 70	00 00
H.Position Reset	Execute		BE EF	03 06	00 IC	D3	06 00	03 70	00 00
H.Size Reset	Execute		BE EF	03 06	00 68	D2	06 00	04 70	00 00
Color Balance R Reset	Execute		BE EF	03 06	00 94	D3	06 00	05 70	00 00
Color Balance B Reset	Execute		BE EF	03 06	00 D0	D3	06 00	06 70	00 00
Sharpness Reset	Execute		BE EF	03 06	00 C4	D0	06 00	09 70	00 00
Color Reset	Execute		BE EF	03 06	00 80	D0	06 00	0A 70	00 00
Tint Reset	Execute		BE EF	03 06	00 7C	D1	06 00	0B 70	00 00
Keystone_V Reset	Execute		BE EF	03 06	00 08	D0	06 00	0C 70	00 00
Keystone_H Reset	Execute		BE EF	03 06	00 98	D8	06 00	20 70	00 00
Auto	Execute		BE EF	03 06	00 91	D0	06 00	0A 20	00 00
Blank on/off	Set	off	BE EF	03 06	00 FB	D8	01 00	20 30	00 00
		on	BE EF	03 06	00 6B	D9	01 00	20 30	01 00
	Get		BE EF	03 06	00 C8	D8	02 00	20 30	00 00
Error Status	Get		BE EF	03 06	00 D9	D8	02 00	20 60	00 00
		(Example of Return)	00 00    01 00    02 00    03 00 (Normal) (Cover-error) (Fan-error) (Lamp-error) 04 00    05 00    06 00 (Temp-error) (Air flow-error) (Lamp-Time-over)						
Power	Set	OFF	BE EF	03 06	00 2A	D3	01 00	00 60	00 00
		ON	BE EF	03 06	00 BA	D2	01 00	00 60	01 00
	Get		BE EF	03 06	00 19	D3	02 00	00 60	00 00
Input Source	Set	RGB1	BE EF	03 06	00 FE	D2	01 00	00 20	00 00
		RGB2	BE EF	03 06	00 3E	D0	01 00	00 20	04 00
		DVI	BE EF	03 06	00 0E	D2	01 00	00 20	03 00
		Video	BE EF	03 06	00 6E	D3	01 00	00 20	01 00
		SVideo	BE EF	03 06	00 9E	D3	01 00	00 20	02 00
	Component	BE EF	03 06	00 AE	D1	01 00	00 20	05 00	
Get		BE EF	03 06	00 CD	D2	02 00	00 20	00 00	
Volume	Get		BE EF	03 06	00 31	D3	02 00	01 20	00 00
	Increment		BE EF	03 06	00 57	D3	04 00	01 20	00 00
	Decrement		BE EF	03 06	00 86	D2	05 00	01 20	00 00

# TECHNICAL (continued)

## Command data chart

Names	Operation type		Header				Command data								
							CRC	Action	Type	Setting code					
Mute	Set	Normal	BE	EF	03	06	00	46	D3	01	00	02	20	00	00
		Mute	BE	EF	03	06	00	D6	D2	01	00	02	20	01	00
	Get	BE	EF	03	06	00	75	D3	02	00	02	20	00	00	
Brightness	Get		BE	EF	03	06	00	89	D2	02	00	03	20	00	00
	Increment		BE	EF	03	06	00	EF	D2	04	00	03	20	00	00
	Decrement		BE	EF	03	06	00	3E	D3	05	00	03	20	00	00
Contrast	Get		BE	EF	03	06	00	FD	D3	02	00	04	20	00	00
	Increment		BE	EF	03	06	00	9B	D3	04	00	04	20	00	00
	Decrement		BE	EF	03	06	00	4A	D2	05	00	04	20	00	00
Color Balance R	Get		BE	EF	03	06	00	01	D2	02	00	05	20	00	00
	Increment		BE	EF	03	06	00	67	D2	04	00	05	20	00	00
	Decrement		BE	EF	03	06	00	B6	D3	05	00	05	20	00	00
Color Balance B	Get		BE	EF	03	06	00	45	D2	02	00	06	20	00	00
	Increment		BE	EF	03	06	00	23	D2	04	00	06	20	00	00
	Decrement		BE	EF	03	06	00	F2	D3	05	00	06	20	00	00
Keystone_V	Get		BE	EF	03	06	00	B9	D3	02	00	07	20	00	00
	Increment		BE	EF	03	06	00	DF	D3	04	00	07	20	00	00
	Decrement		BE	EF	03	06	00	0E	D2	05	00	07	20	00	00
Keystone_H	Get		BE	EF	03	06	00	E9	D0	02	00	0B	20	00	00
	Increment		BE	EF	03	06	00	8F	D0	04	00	0B	20	00	00
	Decrement		BE	EF	03	06	00	5E	D1	05	00	0B	20	00	00
Aspect	Set	4:3, Full	BE	EF	03	06	00	9E	D0	01	00	08	20	00	00
		16:9	BE	EF	03	06	00	0E	D1	01	00	08	20	01	00
		Small	BE	EF	03	06	00	FE	D1	01	00	08	20	02	00
	Get	BE	EF	03	06	00	AD	D0	02	00	08	20	00	00	
Display Position at 16 : 9 or Small	Set	Default	BE	EF	03	06	00	62	D1	01	00	09	20	00	00
		Bottom	BE	EF	03	06	00	F2	D0	01	00	09	20	01	00
		Top	BE	EF	03	06	00	02	D0	01	00	09	20	02	00
	Get	BE	EF	03	06	00	51	D1	02	00	09	20	00	00	
V.Position	Get		BE	EF	03	06	00	0D	83	02	00	00	21	00	00
	Increment		BE	EF	03	06	00	6B	83	04	00	00	21	00	00
	Decrement		BE	EF	03	06	00	BA	82	05	00	00	21	00	00
H.Position	Get		BE	EF	03	06	00	F1	82	02	00	01	21	00	00
	Increment		BE	EF	03	06	00	97	82	04	00	01	21	00	00
	Decrement		BE	EF	03	06	00	46	83	05	00	01	21	00	00
H.Size	Get		BE	EF	03	06	00	B5	82	02	00	02	21	00	00
	Increment		BE	EF	03	06	00	D3	82	04	00	02	21	00	00
	Decrement		BE	EF	03	06	00	02	83	05	00	02	21	00	00
H.Phase	Get		BE	EF	03	06	00	49	83	02	00	03	21	00	00
	Increment		BE	EF	03	06	00	2F	83	04	00	03	21	00	00
	Decrement		BE	EF	03	06	00	FE	82	05	00	03	21	00	00

# TECHNICAL (continued)

Command data chart

Names	Operation type	Header				Command data		
					CRC	Action	Type	Setting code
Sharpness	Get	BE EF	03 06 00	F1 72	02 00	01 22	00 00	
	Increment	BE EF	03 06 00	97 72	04 00	01 22	00 00	
	Decrement	BE EF	03 06 00	46 73	05 00	01 22	00 00	
Color	Get	BE EF	03 06 00	B5 72	02 00	02 22	00 00	
	Increment	BE EF	03 06 00	D3 72	04 00	02 22	00 00	
	Decrement	BE EF	03 06 00	02 73	05 00	02 22	00 00	
Tint	Get	BE EF	03 06 00	49 73	02 00	03 22	00 00	
	Increment	BE EF	03 06 00	2F 73	04 00	03 22	00 00	
	Decrement	BE EF	03 06 00	FE 72	05 00	03 22	00 00	
Video Format	Set	Auto	BE EF	03 06 00	9E 75	01 00	00 22	0A 00
		NTSC	BE EF	03 06 00	FE 71	01 00	00 22	04 00
		PAL	BE EF	03 06 00	6E 70	01 00	00 22	05 00
		SECAM	BE EF	03 06 00	6E 75	01 00	00 22	09 00
		NTSC 4.43	BE EF	03 06 00	5E 72	01 00	00 22	02 00
		M-PAL	BE EF	03 06 00	FE 74	01 00	00 22	08 00
	N-PAL	BE EF	03 06 00	0E 71	01 00	00 22	07 00	
Get	BE EF	03 06 00	0D 73	02 00	00 22	00 00		
HDTV	Set	1080i	BE EF	03 06 00	F2 73	01 00	05 22	00 00
		1035i	BE EF	03 06 00	62 72	01 00	05 22	01 00
	Get	BE EF	03 06 00	C1 73	02 00	05 22	00 00	
PinP Size	Set	off	BE EF	03 06 00	FE 22	01 00	00 23	00 00
		Large	BE EF	03 06 00	6E 23	01 00	00 23	01 00
		Small	BE EF	03 06 00	9E 23	01 00	00 23	02 00
	Get	BE EF	03 06 00	CD 22	02 00	00 23	00 00	
PinP Position	Set	Upper left	BE EF	03 06 00	02 23	01 00	01 23	00 00
		Upper right	BE EF	03 06 00	92 22	01 00	01 23	01 00
		bottom left	BE EF	03 06 00	62 22	01 00	01 23	03 00
		bottom right	BE EF	03 06 00	F2 23	01 00	01 23	02 00
	Get	BE EF	03 06 00	31 23	02 00	01 23	00 00	
PinP Audio ch	Set	RGB	BE EF	03 06 00	BA 22	01 00	03 23	00 00
		Video	BE EF	03 06 00	2A 23	01 00	03 23	01 00
	Get	BE EF	03 06 00	89 22	02 00	03 23	00 00	
PinP Input	Set	Video	BE EF	03 06 00	D6 22	01 00	02 23	01 00
		S-Video	BE EF	03 06 00	26 22	01 00	02 23	02 00
	Get	BE EF	03 06 00	75 23	02 00	02 23	00 00	

# TECHNICAL (continued)

Command data chart

Names	Operation type		Header				Command data								
						CRC	Action	Type	Setting code						
Sync on G	Set	off	BE	EF	03	06	00	CB	D0	01	00	08	30	01	00
		on	BE	EF	03	06	00	5B	D1	01	00	08	30	00	00
	Get		BE	EF	03	06	00	68	D1	02	00	08	30	00	00
WHISPER	Set	NORMAL	BE	EF	03	06	00	3B	23	01	00	00	33	00	00
		WHISPER	BE	EF	03	06	00	AB	22	01	00	00	33	01	00
	Get		BE	EF	03	06	00	08	23	02	00	00	33	00	00
GAMMA	Set	NORMAL	BE	EF	03	06	00	C7	F0	01	00	A1	30	00	00
		CINEMA	BE	EF	03	06	00	57	F1	01	00	A1	30	01	00
		DYNAMIC	BE	EF	03	06	00	A7	F1	01	00	A1	30	02	00
	Get		BE	EF	03	06	00	F4	F0	02	00	A1	30	00	00
IR Remote Front	Set	off	BE	EF	03	06	00	FF	32	01	00	00	26	00	00
		on	BE	EF	03	06	00	6F	33	01	00	00	26	01	00
	Get		BE	EF	03	06	00	CC	32	02	00	00	26	00	00
IR Remote Rear	Set	off	BE	EF	03	06	00	03	33	01	00	01	26	00	00
		on	BE	EF	03	06	00	93	32	01	00	01	26	01	00
	Get		BE	EF	03	06	00	30	33	02	00	01	26	00	00
IR Remote Top	Set	off	BE	EF	03	06	00	47	33	01	00	02	26	00	00
		on	BE	EF	03	06	00	D7	32	01	00	02	26	01	00
	Get		BE	EF	03	06	00	74	33	02	00	02	26	00	00

**NOTE** • The max. 2 IR remote out of 3 (front, rear and top) can be activated.

# REGULATORY NOTICES

## FCC Statement Warning

**WARNING:** This equipment has been tested and found to comply with the limits for a Class B digital device, pursuant to Part 15 of the FCC Rules. These limits are designed to provide reasonable protection against harmful interference in a residential installation. This equipment generates, uses, and can radiate radio frequency energy and, if not installed and used in accordance with the instructions, may cause harmful interference to radio communications. However, there is no guarantee that interference will not occur in a particular installation. If this equipment does cause harmful interference to radio or television reception, which can be determined by turning the equipment off and on, the user is encouraged to try to correct the interference by one or more of the following measures:

- Reorient or relocate the receiving antenna.
- Increase the separation between the equipment and receiver.
- Connect the equipment into an outlet on a circuit different from that to which the receiver is connected.
- Consult the dealer or an experienced radio/TV technician for help.

**INSTRUCTIONS TO USERS:** This equipment complies with the requirements of FCC (Federal Communication Commission) equipment provided that the following conditions are met.

The cables may have to be used with the core set to the projector side. Use the cables which are included with the projector or specified.

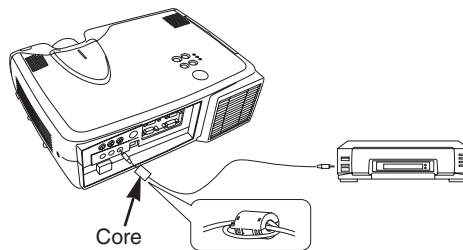

**CAUTION:** Changes or modifications not expressly approved by the party responsible for compliance could void the user's authority to operate the equipment.

## For the Customers in CANADA

**NOTICE:** This Class B digital apparatus complies with Canadian ICES-003.

## Pour les utilisateurs au Canada

**AVIS:** Cet appareil numérique de la Classe B est conforme à la norme NMB-003 du Canada.



Dukane Corporation  
Audio Visual Products Division  
2900 Dukane Drive  
St. Charles, IL 60174-3395  
E-mail: avsales@dukcorp.com

Phone: (630) 762-4040  
Orders: (800) 676-2485  
Information: (800) 676-2486  
Fax: (630) 584-5156  
Parts & Service: (800) 676-2487  
Fax: (630) 584-0984

Audio Visual Products

**DUKANE**

401-8053-00

## **PLEASE READ**

This manual is provided as a free service by Projector.com.

We are in no way responsible for the contents of the manual. We do not guarantee its accuracy and we do not make any claim of copyright. The copyright remains the property of their respective owners.

## **ABOUT PROJECTOR.COM**

Projector.com (<http://www.projector.com>) is your review and buying guide resource for DLP and LCD video projectors.

Visit the site to read the latest projector news and reviews, read and comment on projector specifications, download user manuals and much more.